

July 2009

marlonst[®]

LONGLIFE

Polycarbonate Multi-wall Glazing

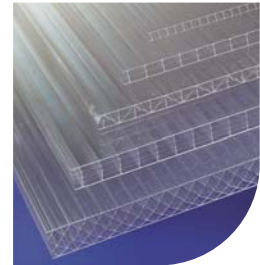



marlon **31**
LONGLIFE



marlonst
LONGLIFE

Structured Polycarbonate

Marlon ST Longlife is a remarkable insulating glazing material manufactured from damage-resistant polycarbonate with added co-extruded longlife protection from the effects of UV weathering.

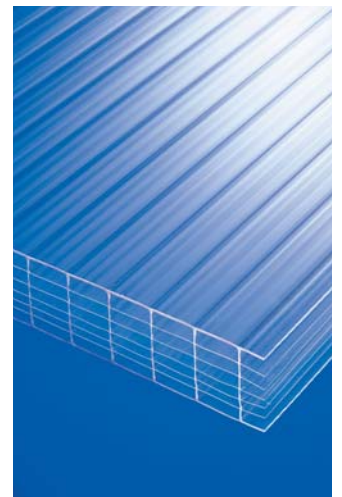

Polycarbonate is best known for its very high impact resistance, fine optical clarity and excellent fire performance.

These unique qualities, along with the extended UV protection and insulating multi-walled structure of Marlon ST Longlife, combine to provide the ideal glazing option for a range of domestic, leisure and industrial applications.

Marlon ST Longlife is manufactured by Brett Martin, a company renowned for its expertise in roof glazing materials produced under Quality Management Systems registered to BS EN ISO 9001:2000.

APPLICATIONS

- Conservatories
- Curved Rooflights
- Industrial Rooflighting
- Secondary Glazing
- Greenhouses
- Covered Walkways
- Swimming Pool Covers
- Internal Glazing

*Pictured opposite:
Brett Martin's opal tinted Marlon ST 25mm
fivewall sheet was used to glaze the underside
of the canopy on the Killanin Stand at
Galway Racecourse, Ballybril, Galway.*





Product Benefits

ENERGY SAVING

In colder climates the insulation benefits of Marlon ST Longlife are an important feature. The 55mm tenwall structure, with a U value of 0.83W/m²K, is one of the most energy efficient glazing materials available, with better insulation properties than most triple glazing or argon filled double glazing, so is ideal for use as part of a heated structure.

LIGHTWEIGHT

Marlon ST Longlife has a very high stiffness to weight ratio. As the sheet weight is very low, support structures need not be as heavy as in the case of traditional materials. This in turn offers savings in structure and installation costs.

RELATIVE U-VALUES W/m²K

Sheet Thickness (mm)	Marlon ST Longlife	Single Glass	Double Glass	Argon filled cavity
4 (Twin)	3.9	5.8	2.65	1.6
6 (Twin)	3.7	5.7	2.65	1.6
8 (Twin)	3.4	5.6	2.65	1.6
8 (Four)	2.8	-	2.65	1.6
10 (Twin)	3.2	5.6	2.65	1.6
10 (Four)	2.5	-	2.65	1.6
16 (Triple)*	2.4	5.4	2.65	1.6
16 (Five)	1.9	-	2.65	1.6
16 (M)	2.2	-	2.65	1.6
16x32 (M)	2.5	-	2.65	1.6
25 (Five)	1.6	-	2.65	1.6
30 (Twin)	2.6	-	2.65	1.6
32 (XX)	1.4	-	2.65	1.6
32 (Seven)	1.25	-	2.65	1.6
32 (Ten)	1.14	-	2.65	1.6
35 (XX)	1.4	-	2.65	1.6
35 (Seven)	1.2	-	2.65	1.6
35 (Ten)	1.08	-	2.65	1.6
40 (Ten)	0.99	-	2.65	1.6
55 (Ten)	0.83	-	2.65	1.6

*16mm Triplewall with 20mm and 16mm rib spacing

COMPARATIVE WEIGHTS OF GLAZING MATERIALS kg/m²

Thickness (mm)	Marlon ST Longlife	Single Glass	Double Glass	Twinwall Acrylic
4 (Twin)	0.8	10	-	-
6 (Twin)	1.3	15	-	-
8 (Twin)	1.5	20	-	-
8 (Four)	1.5	-	-	-
10 (Twin)	1.7	25	-	-
10 (Four)	1.7	-	-	-
16x16 (Triple)	2.5	-	-	-
16x20 (Triple)	2.7	-	-	-
16 (Five)	2.7	-	-	-
16 (M)	2.8	-	-	-
16x32 (M)	4.0	-	-	-
25 (Five)	3.4	-	(6+12+6) 30	-
30 (Twin)	3.5	-	(10+12+6) 40	-
32 (XX)	3.8	-	(12+12+6) 45	6.5
32 (Seven)	3.7	-	-	-
32 (Ten)	3.6	-	-	-
35 (XX)	4.2	-	-	-
35 (Seven)	3.9	-	-	-
35 (Ten)	3.9	-	-	-
40 (Ten)	4.0	-	-	-
55 (Ten)	4.6	-	-	-



Leisure, domestic and horticultural applications benefit from excellent light transmission and thermal insulation values.

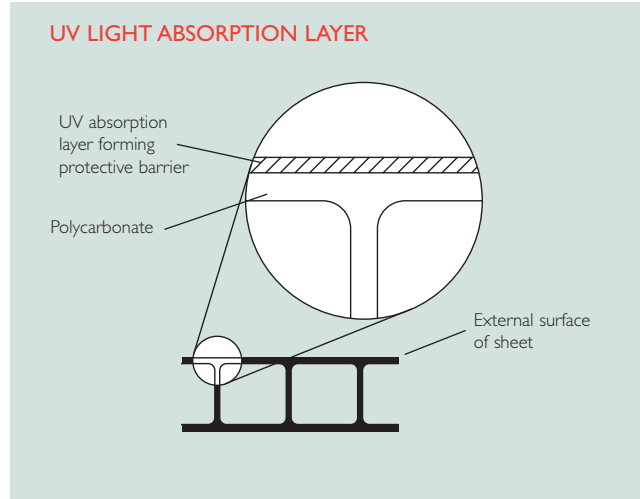

LIGHT TRANSMISSION

Light transmission levels in excess of 80% can be achieved with clear Marlon ST Longlife and will be maintained throughout the life of the sheet. Heat Guard, Bronze and Opal tints offer solar control and can reduce heat build-up.

LONGLIFE

Marlon ST Longlife has a high performance UV absorption layer, co-extruded on the outer surface, which prevents damaging UV radiation from penetrating the sheet. UV protection means longer life and prevention of yellowing and loss of strength.

MARLON ST LONGLIFE

Thickness (mm)	Colour	Light Transmission (%) DIN 5036	Shading Coefficient
25 (Five)	Clear S	68%	0.75
25 (Five)	Bronze B	15%	0.45
25 (Five)	Opal V	30%	0.52
25 (Five)	Bronze Opal	8%	0.42
25 (Five)	Heat Guard Opal	7%	0.30
25 (Five)	Blue Opal	27%	0.54

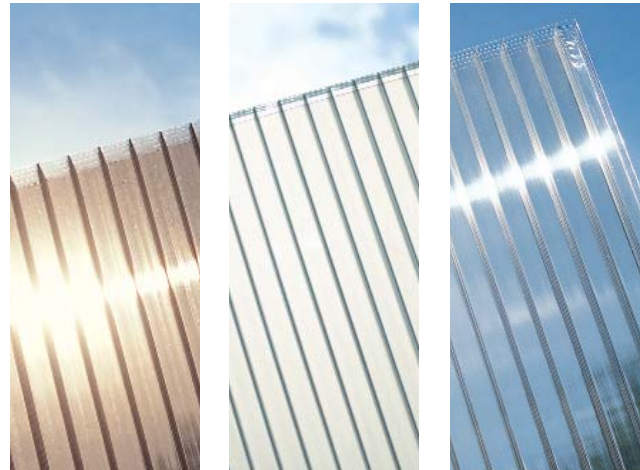

DAMAGE RESISTANCE

Damage to roof glazing can be hazardous and expensive but Marlon ST Longlife offers excellent protection against hailstones, vandalism and accidental damage with an impact resistance up to 200 times greater than glass. This characteristic is maintained over a broad temperature range and prolonged service life.

RESISTANCE TO IMPACT

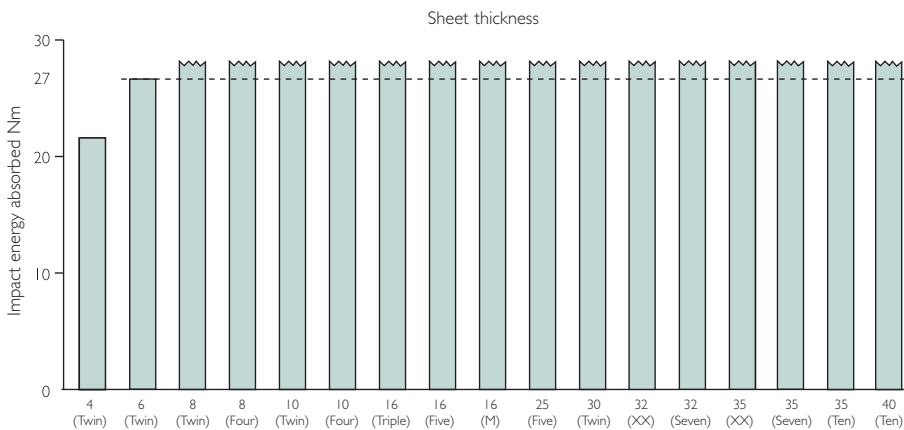

FIRE RESISTANCE

The fire performance of Marlon ST Longlife has been independently tested and certified up to Class 1 surface spread of flame when tested to BS476 Part 7.

10 YEAR WARRANTY

Refer to the Marlon ST Longlife warranty document for full details of the 10 year warranty.



Exceptional strength and the lightweight nature of Marlon ST Longlife make it ideal for commercial locations in flat, curved and barrel vault formats.



SPECIAL OPTIONS

Heat Guard Opal

This sheet deflects sunlight, reduces solar heat gain by up to 50% and has the popular Opal internal finish. A Bronze Opal dual tint sheet is also available.

Double sided UV*

Ultra-violet protection is now available on both sides of Marlon ST Longlife, giving protection in situations where the underside of the sheet may be exposed to the sun e.g. roof vents.

Anti Drip*

Marlon ST Longlife, including double sided UV sheets, can be supplied with an anti-drip coating on the reverse of the sheet, a key requirement for commercial greenhouses.

Technical Assistance

Our Technical Department will provide full information on the suitability of use of the Marlon ST Longlife range and further information is also available in the Marlon ST Longlife Product Guide.

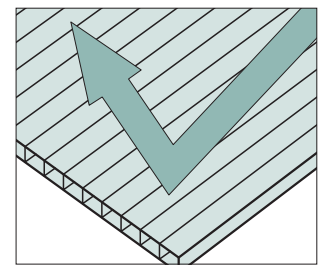
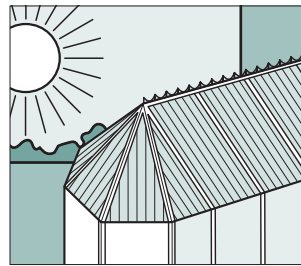

* Subject to minimum order quantities, contact sales office for full details.

TYPICAL PROPERTIES OF MARLON ST LONGLIFE

	Thickness (mm)																				
	4	6	8		10		16		25	30	32		35		40	55					
Structure	Twin	Twin	Twin	Four	Twin	Four	Triple	Triple	Five	M	M	Five	Twin	XX	Seven	Ten	XX	Seven	Ten	Ten	Ten
Sheet thickness mm (±0.5)	4	6	8	8	10	10	16	16	16	16	16	25	30	32	32	32	35	35	35	40	55
Rib spacing (nominal) mm	6	6	10	12.5	10	12.5	16	20	20	17.5	32	20	35	16	20	20	16	20	20	20	20
Sheet width mm	2100	2100	2100	2100	2100	2100	1250	2100	2100	1250	1220	2100	1250	2100	2100	1250	980	2100	1250	1250	1250
Approx weigh g/m ²	800	1300	1500	1500	1700	1700	2500	2700	2700	2800	4000	3400	3500	3800	3600	3600	4200	3900	3900	4000	4600
Light transmission (%) DIN 5036																					
clear S	85	82	82	72	82	74	77	77	69	73	74	68	77	64	64	54	67	63	54	54	52
bronze B	28	26	22	21	33	30	18	18	16	-	-	11	18	11	7	-	11	7	-	-	-
opal V	39	39	39	39	40	38	42	42	39	35	39	30	37	40	33	-	33	31	-	-	-
U-value W/M ² K	3.9	3.7	3.4	2.8	3.2	2.5	2.4	2.4	1.9	2.2	2.5	1.6	2.6	1.4	1.25	1.14	1.4	1.2	1.08	0.99	0.83
Falling dart Gardiner impact at 23°C Nm	21.3	27	>27	>27	>27	>27	>27	>27	>27	>27	>27	>27	>27	>27	>27	>27	>27	>27	>27	>27	>27

The typical properties table includes some non-standard items which may be subject to minimum order quantities and extended lead times.

Structures

MARLON ST PROFILE OPTIONS

Twinwall (Twin) - thicknesses 4, 6, 8, 10 & 30mm



Fourwall (Four) - thickness 8mm & 10mm



Triplewall (Triple) - thickness 16mm



M wall (M) - thickness 16mm

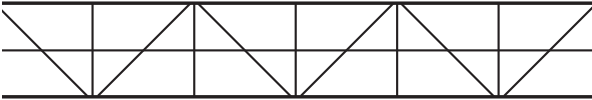

16x16mm (Triple) - Equivalent 16mm performance at a lower weight level



16x32mm M Wall (M) - improved clarity



Fivewall (Five) - thicknesses 16 & 25mm

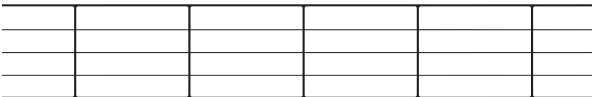

Sevenwall (Seven) - thicknesses 32 & 35mm

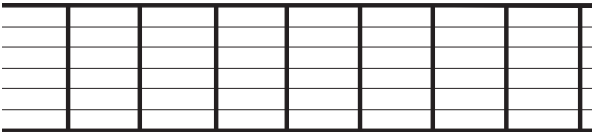

XX wall (XX) - thicknesses 32 & 35mm

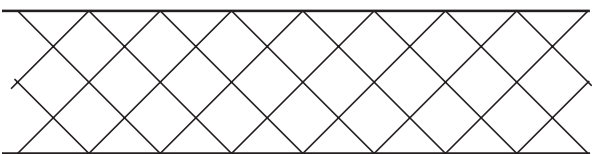

Marlon CST Triplewall - thickness 6mm

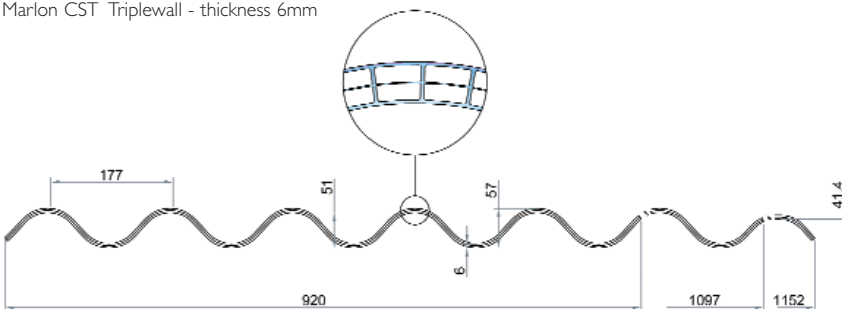

Tenwall - thicknesses 32, 35, 40 & 55mm

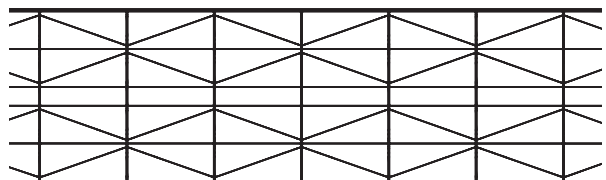

Datasheet available on Marlon CST profiled multiwall polycarbonate sheet.

All reasonable care has been taken in the compilation of the information contained within this literature. All recommendations on the use of our products are made without guarantee as conditions of use are beyond the control of Brett Martin. It is the customer's responsibility to ensure that the product is fit for its intended purpose and that the actual conditions of use are suitable. Brett Martin pursues a policy of continuous product development and reserves the right to amend specifications without prior notice. Marlon is a registered trademark of Brett Martin Ltd.

Brett Martin Ltd

24 ROUGHFORT ROAD
MALLUSK, CO ANTRIM
UK, BT36 4RB

TEL: +44 (0) 28 9084 9999
FAX: +44 (0) 28 9083 6666
Email: mail@brettmartin.com

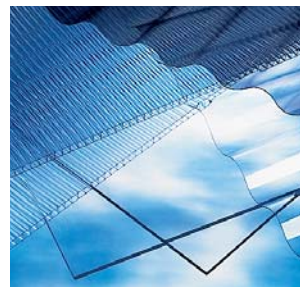

Brett Martin's Marlon brand of polycarbonate includes ranges of solid, profiled and multi-wall sheets.



Certificate No. Q09925

BS EN ISO 9001:2000

BRETT MARTIN 



3777

FOR THE LATEST INFORMATION PLEASE VISIT THE COMPANY'S WEB SITE:
www.brettmartin.com